

# Air to Water Heat Pump

---

## Installation manual

EHS Mono Outdoor Unit AE\*\*\*CXYB\*\*

---

- Thank you for purchasing this Samsung product.
- Before operating this unit, please read this manual carefully and retain it for future reference.



**SAMSUNG**

# Contents

---

<b>Safety Information</b>	<b>4</b>
<b>Handling the box</b>	<b>7</b>
Unpacking the outdoor unit	7
Product line-up and accessories	7
<b>Unit installation</b>	<b>8</b>
Preparing the installation of the outdoor unit	8
Choosing the installation location	8
Safety Zone	9
Moving the outdoor unit	12
Mounting the outdoor unit	12
Outdoor unit drain work	13
<b>Piping installation</b>	<b>14</b>
About the piping work	14
Connecting the water pipes	14
Water Charging	14
Setting capacity and pre-pressure of the expansion vessel	15
Protection of the water circuit freezing	15
Outdoor water piping insulation	17
Minimum active water volume	17
<b>Electrical installation</b>	<b>18</b>
Precautions when connecting the electrical wiring	18
Electrical wiring diagram	18
Outdoor wiring	19
Power and communication cable configuration	20
To connect the power supply	20
To connect the communication cable	20
Control PBA	21
Temp. Sensor for DHW, PV / Peak power control Signal	21
To connect external sensors	22
To connect smart grid	22
<b>System configuration</b>	<b>23</b>
Setting the outdoor options via K-button tactile switches	23
Testing operations	24
FSV Upload / Download	25

<b>Charging refrigerant</b>	<b>26</b>
Important information: regulation regarding the refrigerant used	26
<b>Troubleshooting</b>	<b>27</b>
Troubleshooting of error code	27
<b>Technical data</b>	<b>29</b>
Refrigerant circuit diagram	29
Piping & Wiring diagram	31



***Correct Disposal of This Product  
(Waste Electrical & Electronic Equipment)***

***(Applicable in countries with separate collection systems)***

This marking on the product, accessories or literature indicates that the product and its electronic accessories (e.g. charger, headset, USB cable) should not be disposed of with other household waste at the end of their working life. To prevent possible harm to the environment or human health from uncontrolled waste disposal, please separate these items from other types of waste and recycle them responsibly to promote the sustainable reuse of material resources.

Household users should contact either the retailer where they purchased this product, or their local government office, for details of where and how they can take these items for environmentally safe recycling.

Business users should contact their supplier and check the terms and conditions of the purchase contract. This product and its electronic accessories should not be mixed with other commercial wastes for disposal.

For information on Samsung's environmental commitments and product-specific regulatory obligations, e.g. REACH, visit: <https://www.samsung.com/uk/sustainability/environment/environment-data/>

※ Please refer to the reference guide for details.

# Safety Information

## General

- All materials supplied in this manual are indispensable for the safety of the equipment. Users shall establish appropriate safety and health practices and determine the applicability of regulatory limitations based on the following descriptions before use.
- This unit contains a high flammable refrigerant, R-290. There are fires and explosions when refrigerant leaks. Be sure to follow the storage, installation, maintenance instructions. (Please refer to the reference guide for details.)
- Always disconnect the air to water heat pump from the power supply before servicing it or accessing its internal components.
- Verify that installation and testing operations are performed by qualified personnel.
- Verify that the air to water heat pump is not installed in an easily accessible area (vandalism/ sabotage/ other harmful activities).
- Carefully read the content of this manual before installing the air to water heat pump and store the manual in a safe place in order to be able to use it as a reference after the installation.
- For maximum safety, installers shall always carefully read the following warnings.
- Store the user and installation manual in a safe location and remember to hand it over to the new owner if the air to water heat pump is sold or transferred of ownership.
- This manual explains how to install an outdoor unit and connecting it to the indoor part (Wired remote control and EHS Wi-Fi kit). Use of other types of devices with the control system may damage the device and void the warranty.
- The manufacturer shall not be responsible for damages arising from noncompliant units or parts.
- The manufacturer shall not be responsible for damage originating from unauthorized changes or the improper connection of electric and hydraulic lines. Failure to comply with these instructions or to comply with the requirements outlined in the "Operating limits" table included in the manual shall immediately invalidate the warranty.
- To prevent serious system damage and user injuries, precautions and other notices shall be observed.
- Failure to comply with these instructions or to comply with the requirement on the Operating Range (Heat: -25~35 °C/ DHW: -25~43 °C/ Cool: 10~46 °C) outlined in the Product Specification shall immediately invalidate the warranty.
- Do not use the units if you see some damages on the units and recognize something problematic such as loud noise or smell of burning.
- To prevent electric shocks, fires or injuries, always stop the unit, ultimately rendering the product powerless. Contact Samsung's technical support if the unit produces smoke, if the power cable is hot or damaged or if the unit is very noisy.
- Always remember to inspect the unit, electric connections, refrigerant pipework and protections regularly. These operations shall be performed by qualified personnel only.
- The unit contains moving and electrical parts, which should always be kept out of the reach of children.
- Do not attempt to repair, move, alter or reinstall the unit by unauthorized personnel. These operations may cause product damage, electric shocks, and fires.
- Do not place containers with liquids or other objects on the unit. Never sit or stand on the product.
- All the materials used for the manufacturing and packaging of the air to water heat pump are recyclable.
- The packing material and exhausted batteries of the remote controller(optional) must be disposed of in accordance with local regulations.
- Always make sure that the power supply is compliant with local safety standards.
- For use in Europe: This appliance can be used by children aged 8 years and above and persons with reduced physical, sensory or mental capabilities or lack of experience and knowledge if they have been given supervision or instruction concerning the use of the appliance in a safe way and understand the hazards involved. Children shall not play with the appliance. Cleaning and user maintenance shall not be done by children without supervision.
- This appliance is not intended for use by persons (including children) with reduced physical, sensory, or mental capabilities, or lack of experience and knowledge, unless they have been given supervision or instruction concerning the appliance use by a person responsible for their safety. Children should be supervised to ensure they do not play with the appliance.
- Be sure not to perform power cable modification, extension wiring, and multiple wire connection.
  - It may cause electric shock or fire due to poor connection, poor insulation, or current limit exceedance.
- Do not use means to accelerate the defrosting operation or to clean, other than those recommended by Samsung.
- Do not pierce or burn.
- Be aware that refrigerants may not contain an odour.
- Determine the installation location regarding the conditions cited in this reference guide and obtain the user's approval.
- The outdoor unit must not be placed on its side or upside down, as the compressor lubrication oil will run into the cooling circuit and seriously damage the unit.
- Combine R-290 products only or an error signal appears and the products will not operate. Check with the compatibility table provided by Samsung.
- Make sure to safely dispose of packing materials. Packing materials, such as nails and other metal or wooden pallets may cause injuries to humans and animals by unsafe disposal.

## Installing the unit

### NOTE

- When installing the unit, remember to firstly connect the water pipework, then the electrical lines. Always disassemble the electric lines before the water pipework.
- Upon receipt, inspect the product to verify that it has not been damaged during transport. If the product appears damaged, do not install it, as the refrigerant may leak. A leaking product should be moved to a safe outdoor place. There should be no ignition source within 6 meters. Products should be located where the refrigerant can be safely removed or professionally removed and discarded by service technicians. Immediately report the damage to the supplier of the Samsung products (distributor/retailer/ local Samsung branch office)
- After completing the installation, always carry out a functional test (commissioning, including reporting) and provide instructions on how to operate the air to water heat pump to the user.
- Do not use the air to water heat pump in environments with hazardous substances or close to equipment that releases open flames to avoid the occurrence of fires, explosions or injuries.
- While in installation or relocation of the product, do not mix

the refrigerant with other gases including air or unspecified refrigerant. Failure to do so may cause pressure increase resulting in an explosion, rupture or injury.

- Do not cut or burn the refrigerant container or pipings.
- Use only suitable and clean service equipment such as the manifold gauge, vacuum pump, and charging hose of the R-290 refrigerant. Make sure that any pump and leakage detection device must be suitable for safely working with R-290 refrigerant.



## WARNING

- Failing to do so, may result in fire, explosion, property damage, personal injury or death.
- Installation must be carried out by qualified persons to handle the refrigerant. Additionally, refer to the regulations and laws.
- Be careful not to let foreign substances (lubricating oil, refrigerant other than R-290, water, etc.) enter the refrigerant circuit.
- Products should be installed outdoors with natural ventilation.
- For disposal of the product, follow the local laws and regulations. (Please refer to the reference guide for details.)
- Do not work in a confined or unvented place.
- The work area must be surveyed and inspected prior to any service work, correctly vented and treated always as if the equipment is leaking. The area around the working space must be sectioned off properly.
- The product and the hydraulic system shall be installed in the position where there are no substances that may result in corrosion.
- The following checks shall be performed for installation:
  - There must be a suitable gas detector to look for refrigerant leaks.
  - Notify all workers of work contents.
  - Install "No smoking" and "Do not enter the area" signs.
  - Receive a work permit from manager and work.
  - Do not store flammable materials in the workplace.
  - There should be no sources of ignition anywhere in the workplace.
  - Appropriate fire extinguishing equipment (CO<sub>2</sub> or dry-powder type) should be located nearby and conveniently located.
  - The refrigerant discharged must be sufficiently dispersed and ventilated.
  - The work area should be appropriately ventilated before working on the refrigerant circuit, brazing, or handling electrics.
- To purge air in the refrigerant piping, be sure to use a vacuum pump suitable for handling R-290.
- Note that the refrigerant has no odour.
- The units are not explosion proof so they must be installed with no risk of explosion.
- For installation with handling the refrigerant (R-290), use dedicated tools and piping materials.
- Servicing and installation shall be performed as recommended by the manufacturer. In case other skilled persons are joined for servicing, it shall be carried out under supervision of the person who is competent in handling flammable refrigerants.
- Safety checks are required to minimize the ignition risk for servicing the units containing flammable refrigerants.
- Servicing shall be performed following the controlled procedure to minimize the risk of flammable refrigerant or gases.

- Do not install the unit where there is a risk of combustible gas leakage.
- Do not place the unit near heat sources.
- Be cautious not to generate a spark as follows:
  - Do not remove the fuses with power on.
- After installation, check for leakage. Toxic gas may be generated if it comes into contact with an ignition source such as the fan heater, stove, and cooker.
- In order to service the product, collect the refrigerant in vacuumed recovery cylinders.
- Never directly touch any accidental leaking refrigerant. This could result in severe wounds caused by frostbite.

## Caution of Ignition sources

- Appropriate fire extinguishing equipment should always be available during any type of hot work.
- A dry powder or CO<sub>2</sub> fire extinguisher must be available near the charging area. Please comply with local rules and regulations regarding working with open flames. Always respect waiting times and requirements regarding the type and quantity of the extinguishing equipment.
- Make sure to store the units in a place without continuously operating ignition sources (for example, open flames, an operating gas appliance or an operating electric heater).
- The service engineers shall not use any ignition sources with the risk of fire or explosion.
- Potential ignition sources shall be kept away from the work area where the flammable refrigerant can possibly be released to the surrounding.
- The work area should be checked to ensure that there are no flammable hazards or ignition risks. The "No smoking" sign shall be attached.
- Under no circumstances shall potential sources of ignition be used while in the detection of leakage.
- Make sure that the seals or sealing materials have not degraded.
- Safe parts are the ones with which the worker can work in a flammable atmosphere. Other parts may result in ignition due to leakage.
- Replace components only with parts specified by Samsung. Other parts may result in the ignition of refrigerant in the atmosphere from a leak. In the case of electric components replacement, care should be taken to ensure that electrical terminals, including capacitor terminals, are adequately tightened and secured against loosening and that adequate insulation is provided to avoid live parts shorting together.
- Make sure that the work area is well ventilated before performing a hot work.
- Ventilation of the installation areas must be maintained during the work.
- The ventilation should safely disperse any released gases and preferably expel them into the atmosphere.

# Safety Information

## Leakage detection and refrigerant recovery

- The leakage detector shall be calibrated in a refrigerant-free area.
- Make sure that the detector is not a potential source of ignition.
- Leak detector shall be set at percentage of LFL of the refrigerant and shall be calibrated to the refrigerant employed and the appropriate percentage of the of gas (25% maximum) is confirmed.
- The use of detergents containing chlorine shall be avoided for cleaning because the chlorine may react with the refrigerant and corrode the pipings.
- If leakage is suspected, open flames must be extinguished immediately.
- If a leakage is found while in brazing, the entire refrigerant shall be recovered from the product or isolated (e.g. using shut-off valves). It shall not be directly released to the environment. Oxygen free nitrogen (OFN) shall be used for purging the system before and during the brazing process.
- The work area shall be checked with an appropriate refrigerant detector before and during work.
- Ensure that the leakage detector is appropriate for use with flammable refrigerants.

## Labelling

- The parts shall be labeled to ensure that they have been decommissioned and emptied of refrigerant.
- The labels shall be dated.
- Make sure that the labels are affixed on the system to notify it contains flammable refrigerant.

## Refrigerant recovery

- Empty recovery cylinders shall be evacuated and cooled before recovery.
- When removing refrigerant from the system for servicing or decommissioning, it is recommended to remove the entire refrigerant.
- When transferring refrigerant into cylinders, make sure that only the refrigerant recovery cylinders are used.
- All cylinders used for the recovered refrigerant shall be labelled.
- Cylinders shall be equipped with pressure relief valves and shut-off valves in a proper order.
- The recovery system shall operate normally according to the specified instructions and shall be suitable for refrigerant recovery.
- In addition, the calibration scales shall operate normally.
- Hoses shall be equipped with leak-free disconnect couplings.
- Before starting the recovery, check for the status of the recovery system and sealing state. Consult with the manufacturer if suspected.
- The recovered refrigerant shall be returned to the supplier in the correct recovery cylinders with the Waste transfer note attached.
- Do not mix refrigerants in the recovery units or cylinders.

- If compressors or compressor oils are to be removed, make sure that they have been evacuated to the acceptable level to ensure that flammable refrigerant does not remain in the lubricant.
- The evacuation process shall be performed before sending the compressor to the suppliers.
- Only the electrical heating to the compressor body is allowed to accelerate the process.
- Oil shall be drained safely from the system.

## Installation location requirement of outdoor unit

- The product must be installed outdoors.
- Be sure to observe the suggested Safety Zone. (Page 9)
- Wear protective gloves to unpack, move, install, and service the unit to avoid your hands being injured by the edge of the parts.
- Do not touch the internal parts (water pipes, refrigerant pipes, heat exchangers, etc.) while running the units. And if you need to adjust and touch the units, please observe enough time for the unit to cool down and wear protective gloves.
- Our units shall be installed in compliance with the spaces described in the installation manual, to ensure accessibility from both sides and allow repairs or maintenance operations to be carried out. If the units are installed without complying with procedures described in the manual, additional expenses can be asked because special harnesses, ladders, scaffolding, or any other elevation system for repair service will not be considered part of the warranty and will be charged to the end customer.
- Make sure that (thaw) water runs correctly and unhindered out of the unit at low ambient temperature. If the drainage is exposed to subzero temperatures, additional protection must be taken by the installer, such as installing heater cables in the drain piping. Failing to do so, may cause severe damage to the product and potential leakages of refrigerant into the environment.
- Install the power cable and communication cable of the indoor part and outdoor unit at least 1m away from other electric appliances.
- Protect the unit from rats or small animals. If an animal makes contact with the electric parts, it can cause malfunctions, smoke or fire. Please instruct the customer to keep the area around the unit clean.
- Do not disassemble and alter the heater at your own discretion.
- Wear protective equipment (such as safety gloves, goggles, and headgear) during installation and maintenance works.
- If the installation/repair technicians not be equipped with protective equipment may get injured or threat may happen.
- To prevent ignition, never install motor-driven equipment close to the unit.
- The applicable local, National, and European regulations shall be observed.



# Handling the box

This chapter describes what needs to be done after the boxes with the outdoor and indoor units are delivered on-site.

## NOTE

- Directly after delivery, the unit must be checked for (transport) damage. Any damage must be reported immediately to the applicable distributor of the Samsung products. After inspection, the protective wrapping and box must be put back correctly in order to protect the product.
- It is important to protect the product, therefore transport the product in the protective packaging and keep covered until final installation.
- Preparation of both horizontal and vertical transport (routes and equipment) might be required in order to get the product in the correct installation location.

## Unpacking the outdoor unit

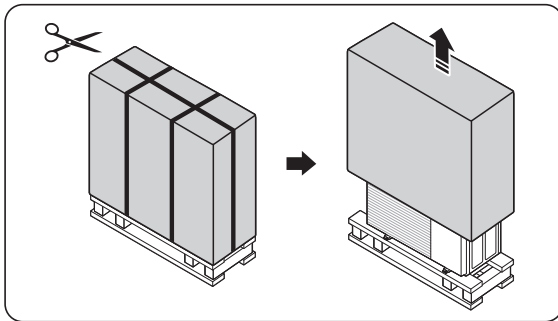

## Product line-up and accessories

### Product line-up

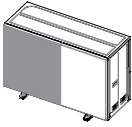
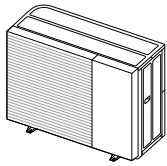

Outdoor unit		
Chassis		
Model name	AE050CXB** AE080CXB**	AE120CXB** AE160CXB**

## Accessories

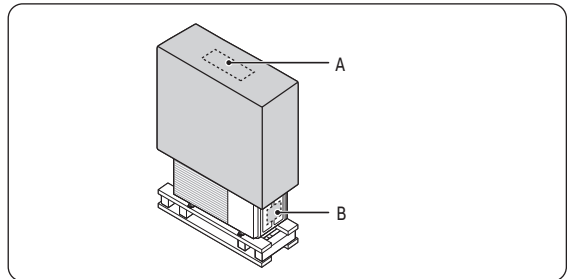



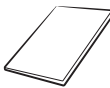

- Keep supplied accessories until the installation is finished.
- Hand the installation manual over to the customer after finishing installation.

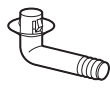

### Accessories in area A

Installation manual (1)	Instruction manual (1)
	

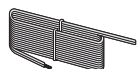
### Accessories in area B

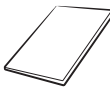
Drain plug (1)	Rubber leg (4)
	
Shut Off Valve IN (inc. Filter) (1)	Temp. Sensor for DHW Tank (1)
	
PV Control / Peak power control cable (1)	EHS Wi-Fi Kit (1)
	
Manual Users & Install for EHS Wi-Fi Kit (1)	
	

# Unit installation

## Preparing the installation of the outdoor unit

Choose a sufficient space for carrying the unit to the installation location in advance.

Do not choose a location where a lot of dust is created such as a construction work site.

### WARNING

- The refrigerant inside the unit is A3- highly flammable (R-290).
- Do not install where there is a risk of combustible gas leakage or heat sources.
- To handle, purge, and dispose the refrigerant, or break into the refrigerant circuit, the worker should have a certificate from an industry-accredited authority in order to be compliant with regulations.
- Verify that the air to water heat pump is not installed in an easily accessible area (vandalism/ sabotage/ other harmful activities).

## Choosing the installation location

### NOTE

- Read the precautions and requirements in the part "General safety information".
- The outdoor unit is designed for outdoor installation only, and for the following ambient temperatures:
  - Space heating mode -25~35 °C
  - Domestic hot water mode -25~43 °C
  - Space cooling mode 10~46 °C

## Decide the installation location regarding the following condition and obtain the user's approval.

- Choose a location that is dry and sunny, but not exposed to direct sunlight or strong winds.
- Do not block any passageways or thoroughfares.
- Choose a location where the noise of the air to water heat pump when running and the discharged air does not disturb any neighbours.
- Choose a position that enables the pipes and cables to be easily connected to the other hydraulic system.
- Install the outdoor unit on a flat, stable surface that can support its weight and does not generate any unnecessary noise and vibration.
- Position the outdoor unit so that the air flows directly towards the open area.
- Place the outdoor unit where there are no plants and animals because they may cause malfunction of outdoor unit.
- Maintain sufficient clearance around the outdoor unit, especially from a radio, computer, and stereo system.
- The outdoor unit shall be installed in an open space that is always ventilated.
- Observe the suggested safety zone.

## Do not install the air to water Heat Pump in the following locations:

- A location where there are any potential dangerous substances like: combustible gas, carbon fiber, mineral oil, arsenic acid, flammable dust, thinner or gasoline, etc.
- A location where corrosive gas such as sulfurous acid gas generates from the vent pipe or air outlet. The copper pipe or connection pipe may corrode and refrigerant may leak.
- A location where the outdoor unit can easily overheat by solar radiation or if the ambient temperature exceeds 35°C during cooling mode. A larger installation space is required for protection against direct solar radiation.
- A location where strong winds may affect the unit. Please also consider enough clearance to avoid issues with the exhaust air from the unit if directed at people.
- A location where air is trapped and may short circuit over the unit. Or where not enough service space is available.
- A too narrow location, as it can lead to problems and potential damage to the product. Also it can lead to the injuries during installation or service work.
- A location where not enough ventilation space exists, especially when installing multiple outdoor units. Obstacles may disturb the airflow over the unit and can potentially cause short circuiting between exhaust air and inlet air and may lead to malfunction.



# Safety Zone

## ⚠ WARNING

- In case of a leakage the refrigerant must not be able to enter the indoor under any circumstances. The Safety Zone shall not have any building openings such as: Windows, Doors, Light wells, Flat roof windows, Air Inlet / Outlet of ventilation systems, etc.
- R-290 refrigerant is heavier than air and can be collected on the ground. There should be no sinking or deepening of the ground in the safety zone.
- The safety zone should not extend to intact buildings or public spaces.
- The safety zone cannot be modified later to violate the protection rules.

(Unit : mm)

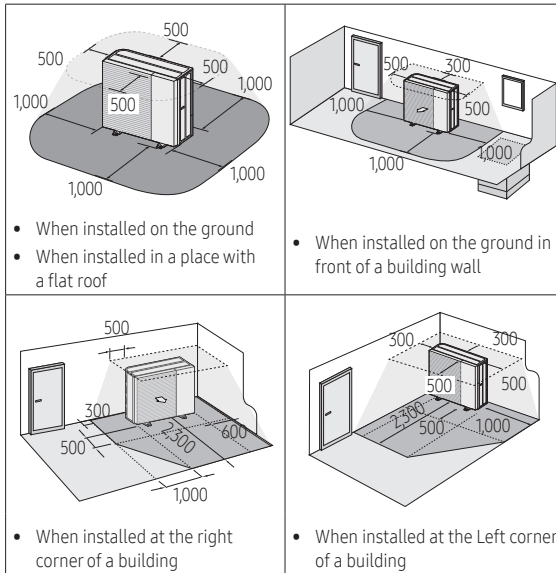

# When installing 1 outdoor unit

(Unit : mm)

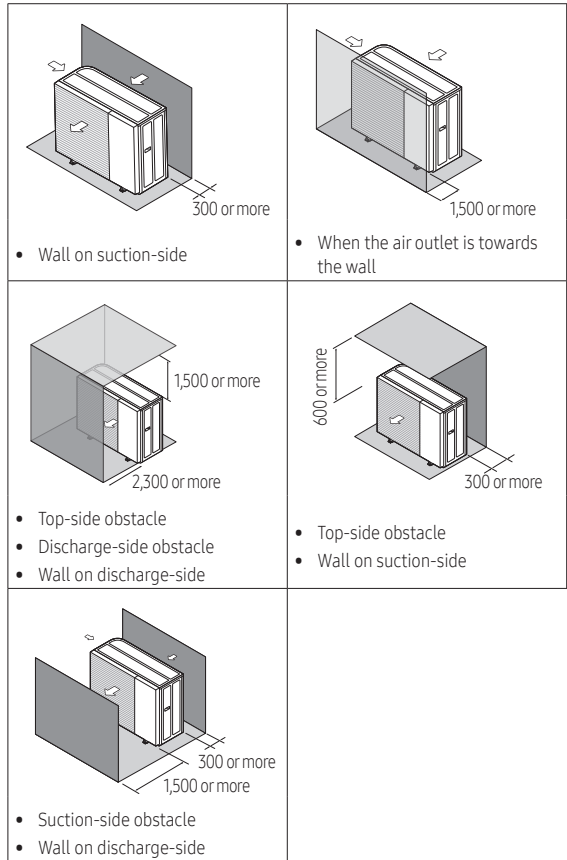

Unit installation

# Unit installation

## When installing more than 1 outdoor unit

(Unit : mm)

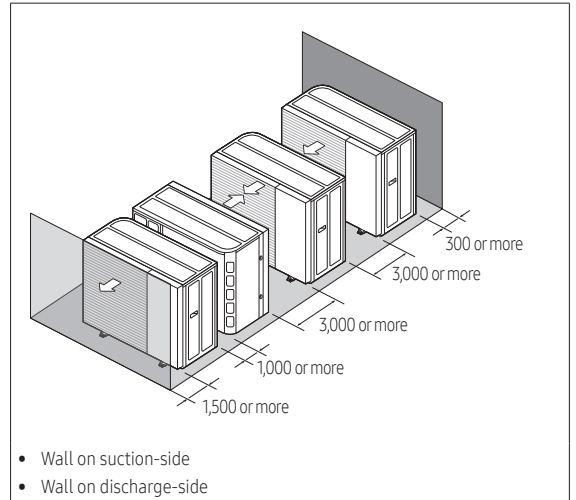
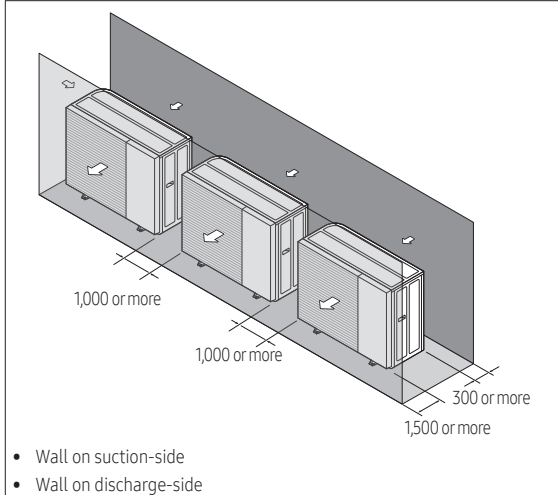
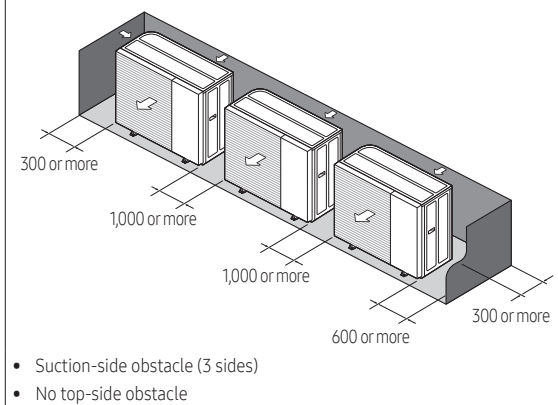
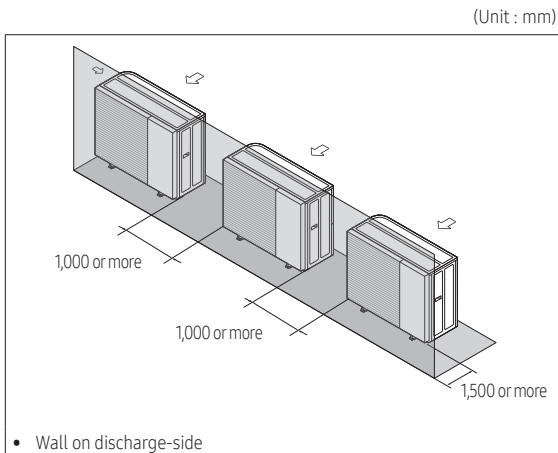

### ⚠ CAUTION

- The units must be installed according to distances declared, in order to permit accessibility from each side, to guarantee correct operation of maintenance or repairing of the products. The unit's parts must be accessible and serviceable under safe working conditions (for people or things).

### Installing the unit at a location with strong winds:

- Outdoor unit must be fixed firmly so that it can withstand the wind speed of the strong wind. If you cannot fix the outdoor unit on the base ground, fixate it sideways or use an extra support structure.
- To prevent exposure to (strong) wind, install a baffle plate on the air discharge side of the unit. (If there is a strong wind facing the outdoor air outlet, it causes a short circuit. This can lead to performance degradation, broken fan (motor), and acceleration of frost.)
- Install a wind protection shielding with anticipation of the dominant wind direction. If the direction of the air discharge part is pointing to the dominant direction of the wind, it could cause performance decrease and potential damage to the product.

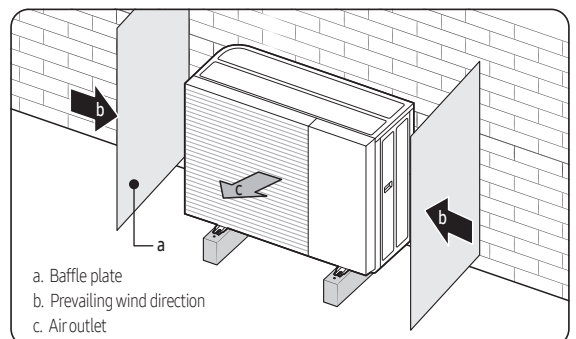

Unit installation

## Installation guide at the seashore

Make sure to follow the below guides when installing at the seashore.

- Do not install the product in a place where it is directly exposed to sea water and sea breeze.
  - Make sure to install the product behind a structure (such as a building) that can block sea breeze.

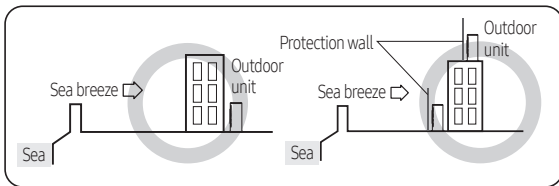
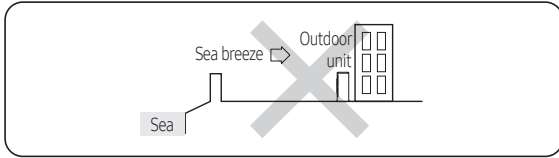

- A protection wall should be constructed with a solid material that can block the sea breeze and the height and width of the wall should be 1.5 times larger than the size of the outdoor unit. (Please secure more than 700 mm of space between the protection wall and the outdoor unit for air circulation.)
- Consider that the salt particles clinging to the external panels should be sufficiently washed off
    - When a product is installed at the seashore, periodically clean it with fresh water to remove attached salt deposits.
  - Make sure that the base of the unit is installed at water level and therefore has optimum drainage. Because trapped water at the bottom of the outdoor unit significantly promotes corrosion.
    - Prevent blockage of the drain hole by foreign substances, by cleaning adequately.
    - Make sure to clean the base plate adequately and regularly as dirt, sand and other substances stay moist and promote corrosion.
  - If the product is installed within 500 m of a seashore, special anticorrosion treatment (like special coating) is required.
    - Please contact your local Samsung representative for further details.
  - When the product is installed at a seashore, periodically clean it with water to remove attached salinity.
  - If the (protective) coating or galvanised steel of the product is damaged during the installation or maintenance, make sure to repair it.
  - Check the condition of the product periodically.
    - Check the installation site every 3 months and perform anticorrosion treatment.

## Selecting a location in cold climates

### NOTE

- When operating the unit in a low outdoor ambient temperature, be sure to follow the instructions described below.

In heavy snowfall areas it is very important to select an installation location where the snow will not affect the unit. If lateral snowfall is possible, make sure that the heat exchanger coil is not affected by the snow. (If necessary construct a lateral canopy)

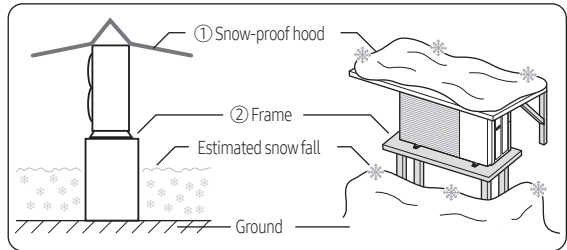

- Construct a large canopy.
- Construct a pedestal.
  - Install the unit high enough off the ground to prevent it from being buried under snow.

## Heavy snow fall area

If the product is installed in a region of heavy snow, allow enough distance between the product and the ground (or piled up snow).

- In areas with heavy snow fall, piled snow could block the air intake. To avoid this, install a frame that is higher than estimated snow fall. In addition, install a snow-proof hood to avoid snow from piling on the outdoor unit.
- If ice accumulates on the base, it may cause critical damage to the product. (e.g., a lakeside in a cold area, the seashore, an alpine region, etc.)
- In a heavy snowfall area, do not install the drain plug and drain cap in the outdoor unit. And, it may cause frozen ground. Therefore, take appropriate measures to prevent it.
- Make a space more than 150 mm between the bottom of the outdoor unit and the ground for installation.
- Make sure that the product is located at least 150 mm above the maximum expected level of snow.

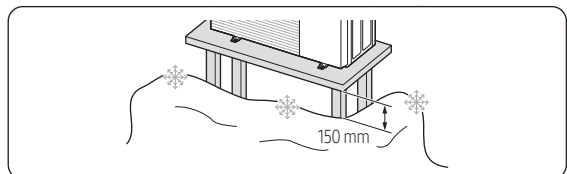

# Unit installation

## Moving the outdoor unit

- Be sure that the moving route is safe by anticipating the weight of the outdoor unit in advance.
- Do not slant the product more than 30° when carrying it. (always keeping the unit upright)
- The surface of the heat exchanger is sharp. Be careful not to be injured while moving and installing by wearing your personal protective equipment (gloves, etc.).

## Moving the outdoor unit by hoisting

- Only hoist the product with using approved lifting straps (according to local regulations). Keep long straps to avoid damage to the panels. Always wear personal protective equipment (safety helmet) when hoisting.

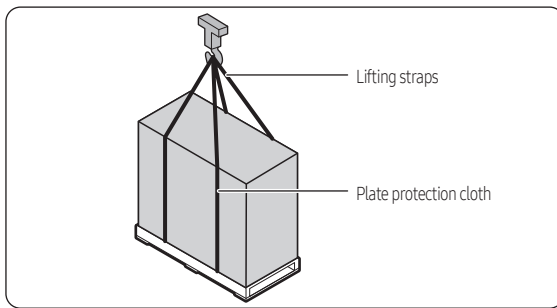

## Moving the outdoor unit with a forklift

- Insert the fork into the wooden pallet at the bottom of the outdoor unit carefully. Be careful that the fork does not damage the outdoor unit. Operating a forklift may require special certification or training according to local regulations.

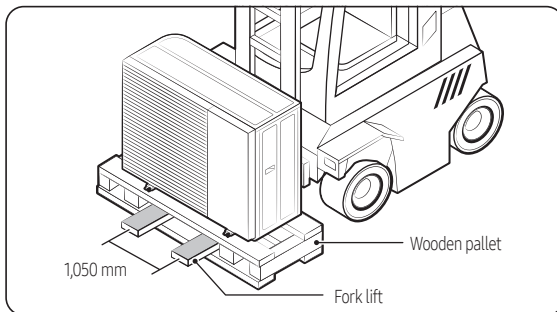

### NOTE

- When looking at the product from the front, there is a center of gravity right from the middle of the product. Refer to the center of gravity mark attached to the product.

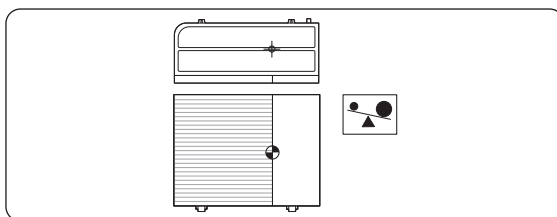

## Mounting the outdoor unit

The outdoor unit must be installed on a rigid and stable base to avoid any increase in the noise level and vibration, particularly if the outdoor unit is to be installed in a location exposed to strong winds or at a height, the unit must be fixed to an appropriate support (wall or ground).

### CAUTION

- When tightening the anchor bolt, tighten the rubber washer to prevent the outdoor unit bolt connection part from corroding.
  - Make a drain outlet around the base for outdoor unit drainage.
  - If the outdoor unit is installed on the roof, you have to check the ceiling strength and waterproof the unit.
  - The anchor bolt must be 20 mm or higher from the base surface.
- ※ In order to prevent freezing of water drains, additional protection such as application of a heating cable may be required.

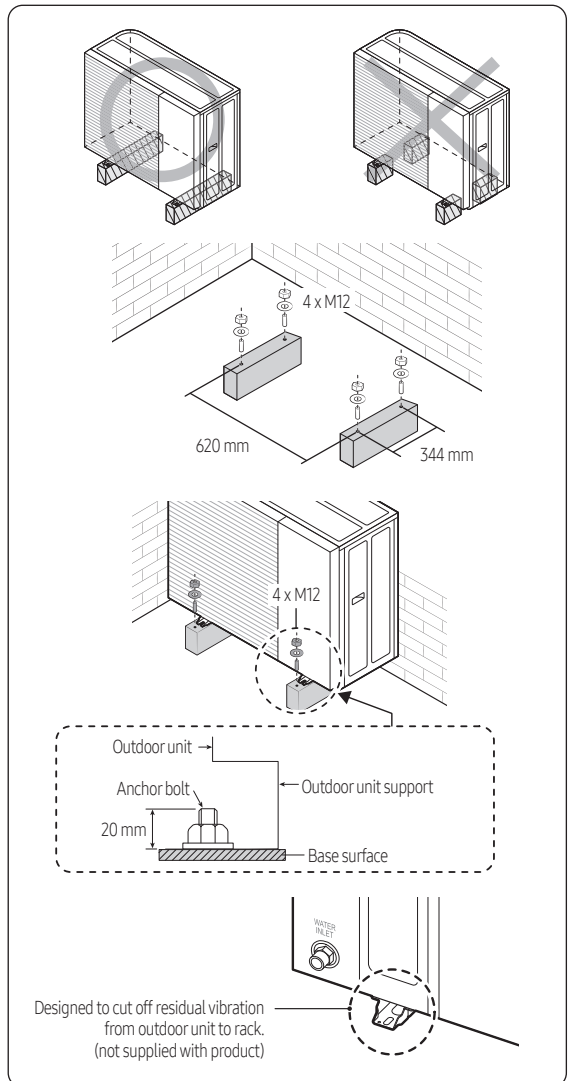

## Outdoor unit drain work

### General area

While the air to water heat pump is operating in heating mode, ice can accumulate on the surface of the condenser.

To prevent ice from growing, the system occasionally enters a defrost mode and the ice on the surface thaws off.

Water dripping from the condenser is guided through the drain holes to prevent ice formation inside the base plate at subzero temperatures.

- In case there is not enough space for natural drainage from the outdoor unit, additional drain work is required. Follow the description as per below:
  - Provide a minimum of 150 mm of free space to the floor.
  - Insert the drain plug into the hole at the bottom of the outdoor unit.
  - Connect the drain hose to the drain plug.
  - Make sure dirt and debris cannot block the drain (hose). Clean the base plate whenever needed.
  - For the remaining holes (that do not have the drain plug), insert the drain cap
  - Make sure that the water dripping from the drain hose runs away correctly and safely.

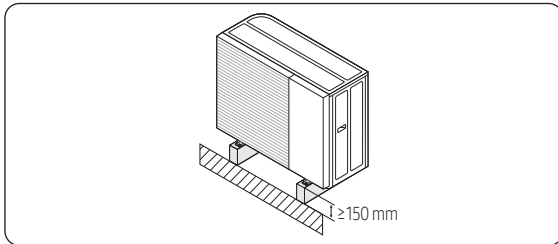

### ⚠ WARNING

- If the drainage is not adequate, it can lead to stagnant water and ice build-up, causing system performance issues and possible damages.

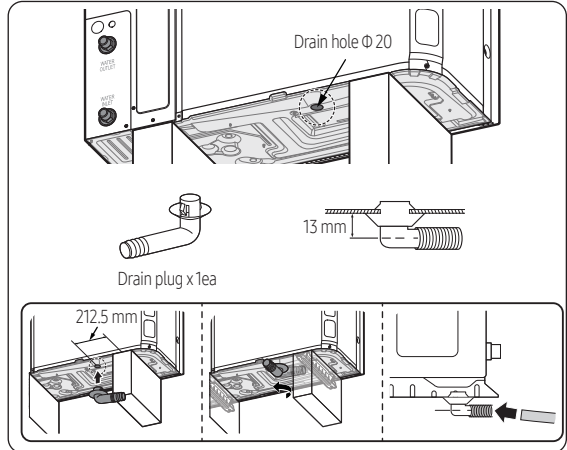

- 1 Prepare a water drainage channel around the foundation, to drain waste water from around the unit.
- 2 If the water drainage from the unit is inadequate, please raise the unit on construction concrete blocks, etc. (the height of the construction should be at least 150 mm).

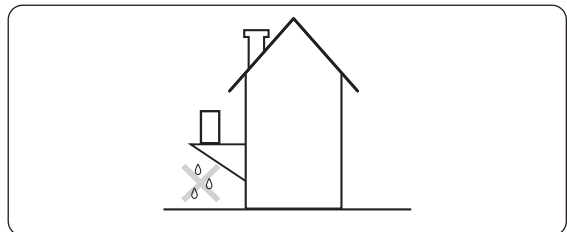

- 3 If you install the unit on a frame, please install a slanted waterproof plate within 150 mm of the underside of the unit to prevent water from splashing against the bottom plate from below.
  - 4 When installing the unit in a place frequently exposed to snow, pay special attention to elevating the foundation as high as the average snow height plus the additional required 150 mm.
  - 5 If you install the unit on a wall support bracket, please install drainage pipework. In order to avoid the drain water from dripping on the floor potentially creating a slippery surface or an ice layer under freezing conditions.
- ※ Please securely mount the outdoor unit before connecting the water piping.

# Piping installation

## About the piping work

Water connections must be made in accordance with the Water Piping and Wiring diagram delivered with the unit, respecting the water inlet and outlet. If air, moisture or dust gets in the water circuit, problems may occur. Therefore, always take into account the following when connecting the water circuit:

- Use clean pipes only.
- Hold the pipe end downwards when removing burrs.
- Cover the pipe end when inserting it through a wall so that no dust and dirt enter.
- Use a good thread sealant for the sealing of the connections.
- The sealing must be able to withstand the pressures and temperatures of the system. When using non-brass metallic piping, make sure to insulate both materials from each other to prevent galvanic corrosion.
- Because brass is a soft material, use appropriate tooling for connecting the water circuit. Inappropriate tooling will cause damage to the pipes.

### ⚠ CAUTION

- Be careful not to deform the unit piping by using excessive force when connecting the piping. Deformation of the piping can cause the unit to malfunction.
- Always use two wrenches (spanners) for tightening or loosening the water connections, and tighten connections with a torque wrench as specified in the below table. If not, connections and parts can be damaged and leak.
- The unit is only to be used in a closed water system. If applications are in open water circuit, it will generate heat exchangers fouling, corrosion, and leak.

Name	Tightening torque	
BSPP1	350~380 kgf•cm	34~37 N•m

## Connecting the water pipes

Connecting the water piping typically follows the below procedure:

- 1 Connect the water piping to the outdoor unit.
- 2 Connect the recirculation piping.
- 3 Connect the drain hose to the drain.
- 4 Fill the water circuit.
- 5 Fill the DHW tank.
- 6 Insulate the water piping.

### 📄 NOTE

- Do not use excessive force when connecting the piping. Deformation of the piping can cause malfunctioning of the unit.

- Connect the shut-off valve (with integrated filter) to the outdoor unit water inlet, using the thread sealant. At this time, the filter should be directed downward so that impurities can be collected.
- Connect the field piping to the shut-off valve.
- Connect the shut-off valve to the outdoor unit water outlet, using the thread sealant.

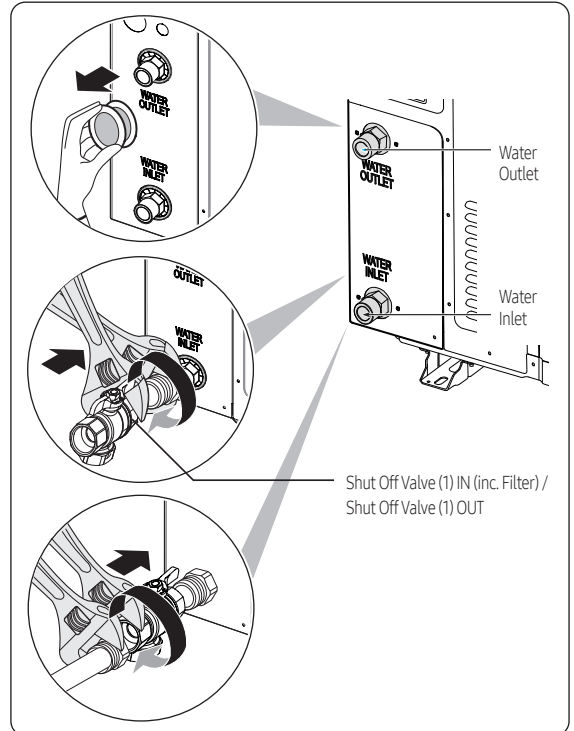

### 📄 NOTE

- About the shut-off valve with integrated filter:
  - The installation of the shut-off valve at the water inlet is mandatory.
  - Mind the flow direction of the valve.

## Water Charging

Fill water into the outdoor unit by opening the shut-off and drain valves.

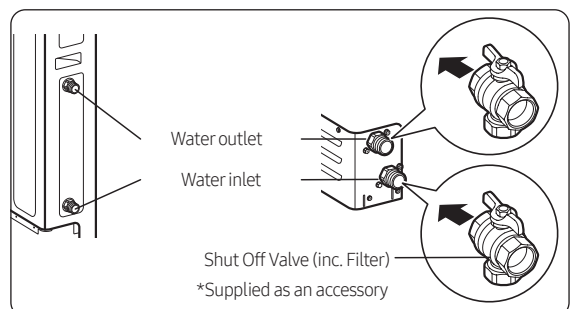



## ⚠ CAUTION

- The operating range of leaving water temperature is 15~75°C at heating conditions and 5~25°C at cooling conditions.
- The minimum required water flow for operation is 7 liters/min. At all times the required water flow-rates should remain. Otherwise, the unit can stop due to a lack of water.
- Water quality must be according to EN directive 98/83 EC. (Please refer to the reference guide for details.)
- Charge the water higher than pressure of 1.0 bar by using make-up water assembly(Field supply). (The water pressure indicated on the manometer will vary depending on the water temperature) The nominal water pressure in the system should remain about 1.0 bar at all times to avoid air entering the water system.

## Setting capacity and pre-pressure of the expansion vessel

When it is required to change the default pre-pressure of the expansion vessel(1 bar), keep in mind the following guidelines:

- ▶ Use only dry nitrogen to set the expansion vessel pre-pressure.
- ▶ Inappropriate setting of the expansion vessel pre-pressure will lead to malfunction of the system. Therefore, the pre-pressure should only be adjusted by a licensed installer.

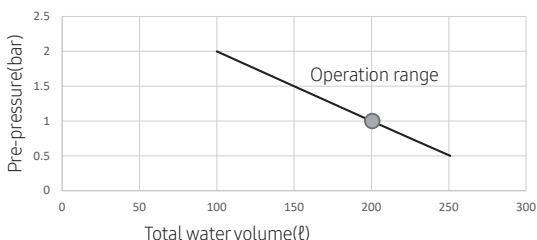

Installation height difference <sup>(a)</sup>	Water volume	
	< 200 Litres	> 200 Litres
<7m	No pre-pressure adjustment required.	Actions required: <ul style="list-style-type: none"> <li>• Pre-pressure must be decreased, calculate according to "Calculating the pre-pressure of the expansion vessel".</li> <li>• Check if the water volume is lower than maximum allowed water volume.</li> </ul>
>7m	Actions required: <ul style="list-style-type: none"> <li>• Pre-pressure must be increased, calculate the appropriate value following by "Calculating the pre-pressure of the expansion vessel".</li> <li>• Check if the water volume is lower than maximum allowed water volume.</li> </ul>	Expansion vessel of the unit too small for the installation.

Installation height difference:

Height difference(m) between the highest point of the water circuit. If the unit is located at the highest point of the installation, the installation height is considered 0m.

- When Expansion vessel has a capacity 10 liters and 1bar pre-charged. Water volume of total system for reliable performance is minimum 30 Liter (AE050/080CXYB\*\*), 50 Liter (AE120/160CXYB\*\*).

Calculating the pre-pressure of the expansion vessel

The pre-pressure(Pg) to be set depends on the maximum installation height difference(H) and is calculated as below :

$$Pg = (H/10 + 0.3) \text{ bar}$$

## Protection of the water circuit freezing

To prevent the hydraulic components from freezing, it has a freezing protection function that includes activation of the pump at low temperatures.

However, in case of a power failure, these functions cannot guarantee protection.

To protect the water circuit from freezing, any one of the following acts shall be performed.

- Add glycol to water. Glycol lowers the freezing point of water.
- Install the anti-freeze valve. The anti-freeze valve discharges water from the system before it freezes.

## Freeze protection by glycol

Freeze protection solutions must use propylene glycol with a toxicity rating of Class 1 as listed in Clinical Toxicology of Commercial Products, 5th Edition.

## ⚠ WARNING

- Ethylene glycol is toxic and must not be used in the primary water circuit in case of any cross-contamination of the portable circuit.
- If you add glycol to the water, do NOT install anti-freeze valve, to avoid Glycol leaking out of the anti-freeze valves into the environment.
- If an anti-freeze protection is used, it will result in increased pressure drop and it may also cause a slight capacity reduction.

## ⚠ CAUTION

- Due to the presence of glycol, corrosion of the system is possible. Uninhibited glycol will turn acidic under the influence of oxygen. The acidic uninhibited glycol attacks metal surfaces and forms galvanic corrosion cells that cause severe damage to the system.
- A glycol with corrosion inhibitors is selected to counteract acids formed by the oxidation of glycols.
- No automotive glycol is used because their corrosion inhibitors have a limited lifetime and contain silicates which can foul or plug the system.
- Galvanized pipes are NOT used in glycol systems since the presence may lead to the precipitation of certain components in the glycol's corrosion inhibitor.

# Piping installation

## Unit resistance and PHE resistance by glycol concentrate

The unit is composed of water pipes and PHE basically. To ensure correct operation and predict the expected performance, Flow and Resistance table can be used and Flow and resistance characteristic is dependent on Glycol concentration.

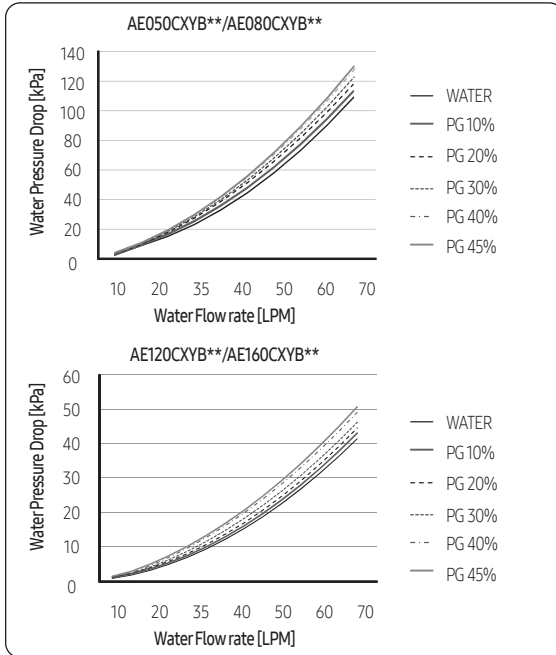

Changing Glycol concentration can cause the pressure drop of the system and it can lead to make flow rate slow.

Just in case of performance degradation, installer shall be careful of flow rate changes.

The required concentration of glycol depends on the lowest expected outdoor temperature, and on whether you want to protect the system from bursting or from freezing. To prevent the system from freezing, more glycol is required.

Add glycol according to the table below.

Freezing Points of Propylene Glycol - Water Mixtures		
Percent Propylene Glycol [wt.%]	Freezing Point [°F]	Freezing Point [°C]
0	32	0
10	26	-3
20	20	-7
30	10	-12
36	0	-18
40	-5	-20
43	-10	-23
48	-20	-29

## Freezing protection: Anti-freeze valves

In order to prevent system water from freezing inside the pipework during subzero ambient conditions after a sudden power outage, anti-freeze valves are advised if glycol is not a suitable solution.

An anti-freeze valve opens when the medium (water) is below a certain low temperature value.

When using the EHS for cooling in the summertime, an anti-freeze valve with ambient sensor is required to avoid unwanted opening due to low water temperatures.

To protect the field piping against freezing, install the following parts:

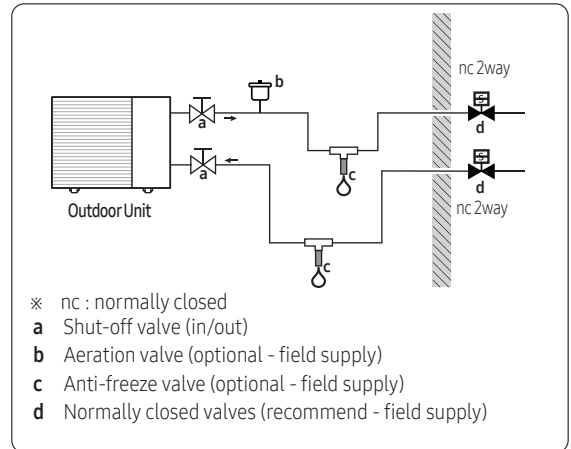

## CAUTION

- If the system is utilized for both cooling operations (summer), please install anti-freeze valves with an ambient air sensor in order to avoid valve opening due to low water temperatures. Alternatively set FSV #1012 (minimum cooling set point) to 7 °C or higher in order to prevent triggering the anti-freeze valves during cooling operation.

Part	Description
	If necessary, you can close the valve to isolate the water in the outdoor unit.
	Aeration valve (to clear the water from the system).
	Protection for the field piping. The anti-freeze valve must be installed (field supply) <ul style="list-style-type: none"> <li>Vertically to allow water to flow out properly and free from obstructions.</li> <li>At the lowest point in all field piping.</li> <li>In the coldest part and away from heat sources.</li> </ul>
	Water isolation inside the house in case of a power outage. Normally closed valves (located indoors near the inlet/outlet pipes) can prevent all water in the indoor plumbing from draining when the anti-freeze valve is opened. (field supply) <ul style="list-style-type: none"> <li>Power outage: The normally closed valves close to shut off the water in the house. When the anti-freeze valve is open, only water outside the house is drained.</li> <li>Other situations (eg pump failure): When the anti-freeze valves open when the power is still applied to the normally closed valves, the system will drain completely.</li> </ul>

## Outdoor water piping insulation

The complete water circuit, inclusive all the piping, must be insulated to prevent condensation during cooling operation and reduction of the heating and cooling capacity as well as prevention of freezing of the outside water piping during winter time. The thickness of the sealing materials must be at least 9 mm with  $\lambda=0.035$  W/mK in order to prevent freezing on the outside water piping.

If the temperature is higher than 30°C and the humidity is higher than RH 80%, then the thickness of the sealing materials should be at least 20 mm in order to avoid condensation on the surface of the sealing.

For piping in free air, it is recommended to use the insulation thickness as shown in the below table as a minimum (with  $\lambda=0.035$  W/mK).

Piping length (m)	Minimum insulation thickness (mm)
< 20	19
20 ~ 30	32
30 ~ 40	40
40 ~ 50	50



### NOTE

- This recommendation ensures good operation of the unit, however, local regulations may differ and shall be followed.

## Minimum active water volume

The minimum active water volume of the system is the amount of water which is always pumped around, even when all valves in the system are closed. The use of a buffer tank can increase the active volume and therefore the operation time between compressor start and stop.

Ideally, systems should be designed for around 12 to 15 minutes of operation, in order to meet with our declared efficiencies.

This time frame is based on a maximum of 4 On/Off cycles per hour.

The required minimum active water volume can be calculated via the below stated formula:

$$V_{\min} = \frac{t_{\min} \times \Phi_{\min}}{C_{\text{water}} \times \Delta T}$$

$V_{\min}$ : Minimum active volume [dm<sup>3</sup>]

$t_{\min}$ : Minimum allowed operation time is 12 min or 720 sec per cycle [s, sec]

$\Phi_{\min}$ : Minimum compressor output [kW = kJ/s]

$C_{\text{water}}$ : Specific heat of water (4,2) [kJ/kg\*K]

$\Delta T$ : Temperature increase (5-10 K) [K]

# Electrical installation

## Precautions when connecting the electrical wiring

### ⚠️ WARNING

- Make sure first the water piping is connected before the electrical wiring work.
- When removing or relocating the equipment, power off first and then disconnect the electrical wiring.
- Connect the air to water heat pump to a protected earth (PE) before connecting the phase and neutral to the product.
- Follow the local installation standards and regulations when installing electrical wiring. Electrical wiring should be installed by a certified electrician or certified installer. Failing to comply, might lead to damaging the product, starting a fire and personal injury, electrocution or death.
- Make sure that wiring work must be done by an authorized electrician. The wiring materials and wiring work must comply with the applicable legislation.
- Always verify that a suitable grounding connection is available.
- Verify that the voltage and frequency of the power supply comply with the specifications and that the installed power is sufficient to ensure the operation of any other domestic appliance connected to the same electric lines.
- Always verify that the cut-off and protection switches are suitably dimensioned.
- Verify that the air to water heat pump is connected to the power supply in accordance with the instructions provided in the wiring diagram included in the manual.
- Always verify that electric connections (cable entry, the section of leads, protections...) comply with the electric specifications, local regulations and installation standards and with the instructions provided in the wiring scheme. Always verify that all connections comply with the standards applicable to the installation of air to water heat pumps.
- Depending on the condition of power supply, unstable power or voltage may cause malfunction of the parts or control system. (Avoid using power supply from an electric generator, like on a ship etc).

### ⚠️ CAUTION

- Make sure that you earth the cables.
  - Do not connect the earth wire to the gas pipe, water pipe, lighting rod or telephone wire. If earthing is not complete, electric shock or fire may occur.
- Install the circuit breaker.
  - Failing to install a circuit breaking device may result in electric shock and fire occurrence.
- Install the power cable and communication cable of the indoor part and outdoor unit according to IEC 60364-1 (Electrical installations and protection against electric shock).
- Be sure to install both an earth leakage detector and circuit breaker with specified capacity in accordance with relevant local and national regulations.
  - If it is not installed properly, it may cause electric shocks and fire.

## Electrical wiring diagram

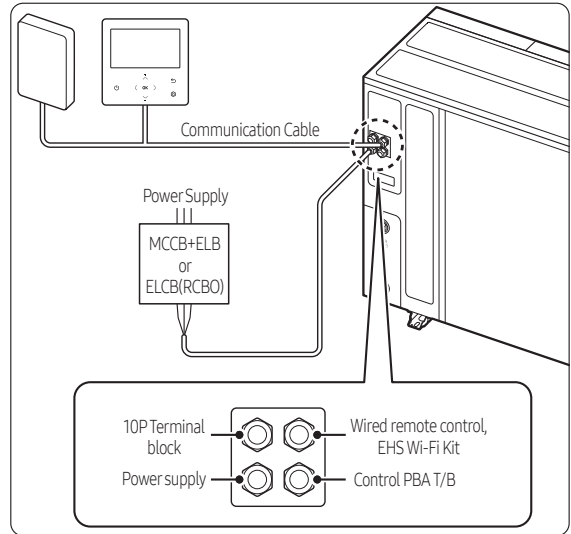

## Specification of power cable

- **1 Phase**
  - The power cables are not supplied with the air to water heat pump.
  - Power supply cords of parts of appliances for outdoor use shall not be thinner than polychloroprene sheathed flexible cord (Code designation IEC:60245 IEC 57 / CENELEC:H05RN-F)
  - This equipment complies with IEC 61000-3-12.

Outdoor unit	Hz	Rated		Voltage Range		MCA	MFA
		Volts	Min	Max	Min Circuit Amps.	Max Fuse Amps.	
AE050CXYBEK	50	220-240	198	264	16.1	17.6	
AE080CXYBEK	50	220-240	198	264	26	28.6	
AE120CXYBEK	50	220-240	198	264	32	35.2	
AE160CXYBEK	50	220-240	198	264	32	35.2	

- **3 Phase**
  - The power cables are not supplied with the air to water heat pump.
  - Power supply cords of parts of appliances for outdoor use shall not be lighter than polychloroprene sheathed flexible cord (Code designation IEC:60245 IEC 66 / CENELEC:H07RN-F)
  - This equipment complies with IEC 61000-3-12 provided that the short-circuit power (SSC) is greater than or equal to 3.3[MVA] at the interface point between the user's supply and the public system. It is the responsibility of the installer to ensure, by consultation with the energy company if necessary, that the equipment is connected only to a supply with a short-circuit power (SSC) greater than or equal to 3.3[MVA].

Outdoor unit	Rated		Voltage Range		MCA	MFA
	Hz	Volts	Min	Max	Min Circuit Amps.	Max Fuse Amps.
AE080CXYBGK	50	380-415	342	457	16.1	17.7
AE120CXYBGK	50	380-415	342	457	16.1	17.7
AE160CXYBGK	50	380-415	342	457	16.1	17.7

### Terminal block specification

- 1 Phase

(Unit: mm)

AC power: M5 screw

Communication: not used

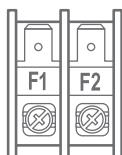
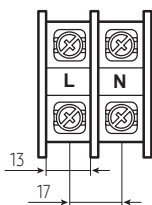

- 3 Phase

(Unit: mm)

AC power: M5 screw

Communication: not used

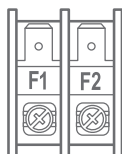
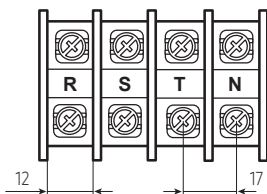

Tightening Torque (kgf • cm)		
M4	12-18	Communication : F1, F2
M5	20-30	1phase AC power : L, N
		3phase AC power : L1(R), L2(S), L3(T), N

### Outdoor wiring

- 1 Open the switch side cover.

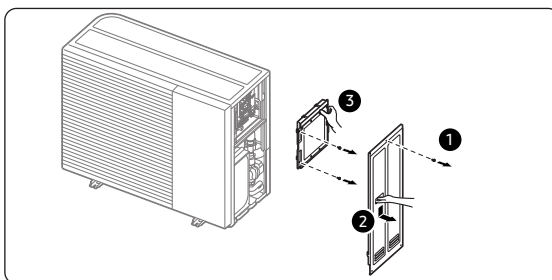

- 2 Remove 2 screws and pull the plate to the left.

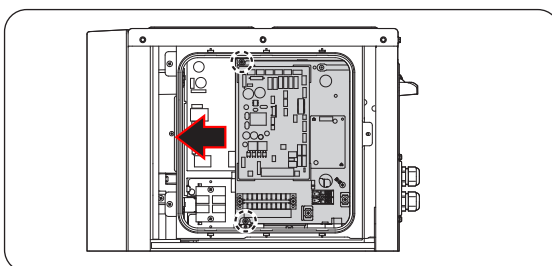

- 3 If the plate is rotated to where the hook is, it will be fixed to the hook.

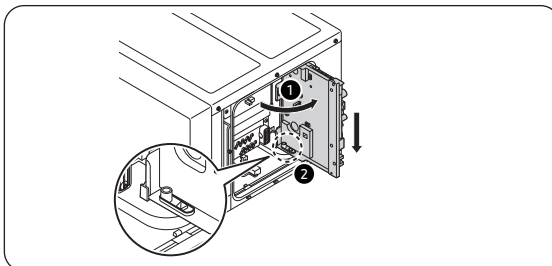

- 4 Insert the cables at the rear of the unit, and route them through the factory mounted cable sleeves into the switch box.

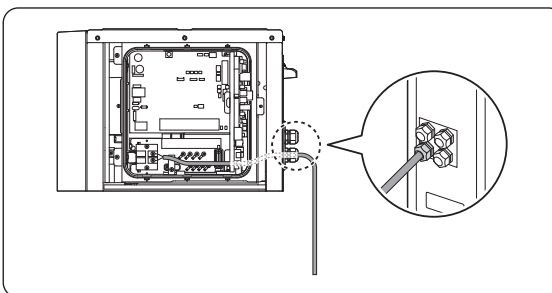

# Electrical installation

## Power and communication cable configuration

- Power supply cable must be guided through the knock-out hole on the bottom-right or right side of the cabinet.
- Guide the communication cable through the designated knockout hole on the bottom-right side of the front part.
- Install the power and communication cable using a separate cable protection tubing.
- Fix the conduit to the knock-out hole on the outdoor unit by using a conduit bushing and nut.

## To connect the power supply

- Two cables must be connected to the outdoor unit
  - The communication cable between the indoor part and outdoor unit.
  - The power cable between the outdoor unit and the auxiliary breaker.
- Especially for the Russian and European market, before installation, the supply authority should be consulted to determine the supply system impedance to ensure compliance.

### CAUTION

- You should connect the power cable into the power cable terminal and fasten it with a clamp.
- The unbalanced power must be maintained within 2% of the supply rating.
  - If the power is unbalanced greatly, it may shorten the life of the electrical components. If the unbalanced power is exceeding 4% of the supply rating, the control kit is protected, stopped and an error code is displayed.
- To protect the product from water and possible shock, keep the power cable and the connection cord of the control kit and outdoor units within ducts (with appropriate IP rating and material selection for your application).
- Ensure that the main supply connection is made through a disconnection switch within your arm's reach, that disconnects all poles, with contact gap of a least 3 mm.

## Route the cable through the frame

- Connect the wires to the terminal block and fix the cable with the cable tie.

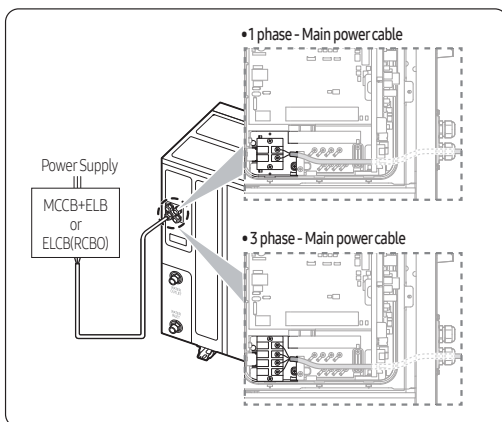

- When installing electrical wiring: tension on the cable(s) must be avoided.
- Earth wire for the outdoor unit cables must be clamped to a suitable ring terminal clamp (not supplied)
- For the power cable, use the grade H07RN-F or H05RN-F materials.
- Power supply cords of parts of appliances for outdoor unit use shall not be thinner than polychloroprene sheathed flexible cord. (Code designation IEC:60245 IEC 57 / CENELEC: H05RN-F or IEC:60245 IEC 66 / CENELEC: H07RN-F)

## To connect the communication cable

- The communication cable between the indoor part and outdoor unit.
- Route the cable through the frame.

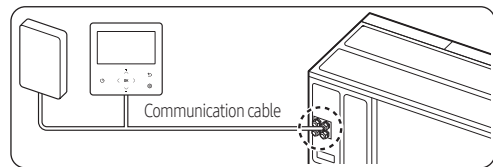

- Specification of communication cable

Communication cable	Specifications
0.75 mm <sup>2</sup> , 2 wires shielded	LiYCY



# Control PBA

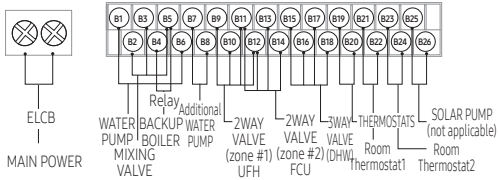
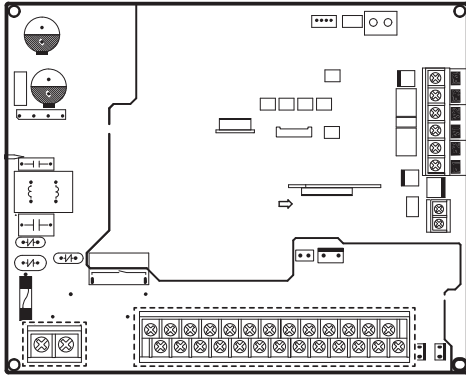

NOT USED DC DIGITAL WIRED REMOTE OUTPUT GROUND CONTROLLER

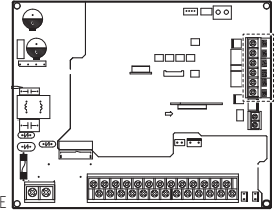

Part code	Part name	Terminal	Terminal description
TB-C	Communication & DC 12V	#1:COM1 (F1)	Not used
		#2:COM1 (F2)	
		#3:V1 (DC 12V)	DC 12 V
		#4:V2 (GND)	Digital ground
		#5:COM2 (F3)	Wired remote controller
		#6:COM2 (F4)	

## Temp. Sensor for DHW, PV / Peak power control Signal

※ UFH : Under floor heating

Terminal No.	Function	Input/Output	Max. current	Description	Remark
B1/B6	WATER PUMP	AC 230V output	0.5A	Water pump operation (maximum input power of pump 100W)	
B2/B3/B5	MIXING VALVE	AC 230V output	22mA	Mixing Valve operation	Option
B4/B5	BACKUP BOILER	AC 230V output	10mA	Signal output for Backup Boiler	Option
B7/B8	WATER PUMP	AC 230V output	0.5A	Additional Water pump operation (maximum input power of pump 100W)	Option
B9/B10/B11/B12	2WAY VALVE #1	AC 230V output	22mA	2WAY VALVE operation for Zone#1 (UFH)	Option
B13/B14/B11/B12	2WAY VALVE #2	AC 230V output	22mA	2WAY VALVE operation for Zone#2 (UFH)	Option
B15/B16/B17/B18	3WAY VALVE	AC 230V output	22mA	3WAY VALVE operation for DHW	Option
B19/B20	THERMOSTATS	AC 230V output	22mA	Power to external thermostat(s)	Option
B21/B22	THERMOSTAT1	AC 230V input	22mA	Thermostat for zone#1 (UFH) Cooling/Heating Signal	Option
B23/B24	THERMOSTAT 2	AC 230V input	22mA	Thermostat for zone#2 (FCU) Cooling/Heating Signal	Option
B25/B26	SOLAR PUMP	AC 230V input	10mA	Signal input from Solar Pump/DHW Tank Thermostat	Option

External wiring to control a switch of relay by a installer

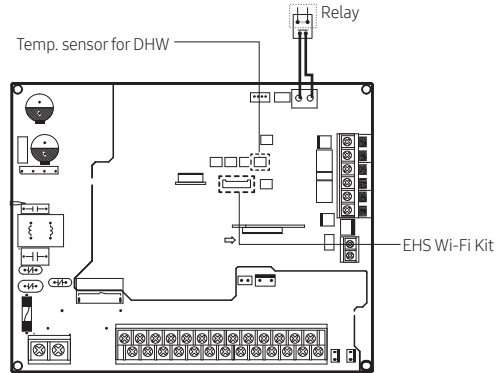

### Connecting a temp. sensor wire into DHW

- Put the sensor side of a temp. sensor wire into the designated location in a DHW.
- Connect the other side of the line at CNS042.

### Connecting a PV(Photovoltaic) Signal / Peak power control Signal

- Install as above diagram.
- Connect the PV / Peak power control signal wire to the 'CNS046' connector.

### NOTE

- It operates according to the setting of FSV, and both functions can not be used at the same time. (PV Control / Peak power control)

# Electrical installation

## To connect external sensors

- When the room temperature for zone2 is controlled via a remote sensor, please connect the zone sensor (white, supplied) to the correct terminals (15/16)
- To control the supply water temperature for both zone1 and zone2, it is required to install the supplied sensor(s) at the correct position. Please connect zone sensors (Tw2\_z1 and Tw2\_z2) to the below mentioned terminal block at the correct terminals (17/18 and 19/20)

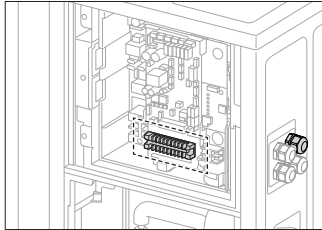
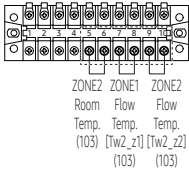

### CAUTION

- When connecting sensors, use a Thermistor with the specifications of 10 kΩ at 25 °C, B constant = 3435 k.

## To connect smart grid

- To control the ClimateHub via external smart grid (SG) input signals (potential free, dry contact), please connect to the correct terminals (Signal1 (1/2), Signal2 (3/4)). If needed use relays, not supplied with the product.

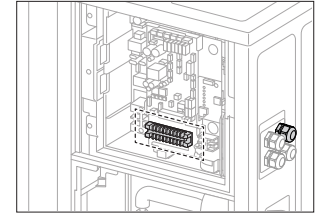
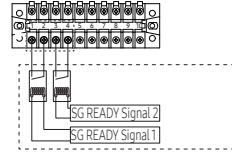

SG READY Signal 1	SG READY Signal 2	Description
Short	Open	Forced thermo off operation
Open	Open	Normal operation
Open	Short	Heating / DHW setting temperature 1step-up operation
Short	Short	Heating / DHW setting temperature 2step-up operation

### CAUTION

- These parts are optional and not included with the product.
- Turn off the ELCB first before connecting the SG Ready.

# System configuration

## Setting the outdoor options via K-button tactile switches

Setting the correct options for the outdoor unit for site specific conditions via K-button tactile switches and explanation of their functions.

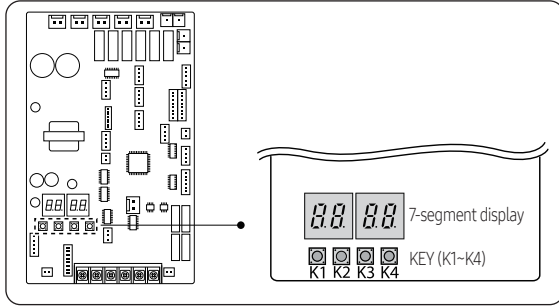

### Setting the option

- Press and hold K2 to enter the option setting. (Only available when the operation is stopped)
  - When entering the option setting, the display will show the following:

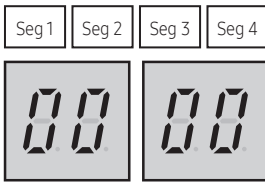

- Seg 1 and Seg 2 will display the number for the selected option.
  - Seg 3 and Seg 4 will display the number for the set value of the selected option.
- After entering the option setting mode, shortly press the K1 switch to go to the desired option to change, indicated by Seg 1, Seg 2 and select the desired option. (Example)



- After selecting the desired option, you can shortly press the K2 switch to adjust the value of the option, as indicated by Seg 3 and Seg 4, and change the function setting for the selected option.

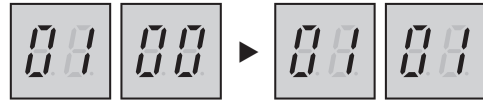

- After selecting the function setting for the selected options, press and hold the K2 switch for 2 seconds to store the value. The changed value of the option will be saved when the entire segment display blinks and tracking mode begins.

### CAUTION

- If the above instruction is not exactly followed, there is a risk that changed option settings are not saved.

- To restore the previous setting, press and hold the K1 button.
- To call for the factory default setting, press and hold K4 during the option setting mode.
  - After the factory default value is displayed, it needs to be saved. Press and hold the K2 button. When the segments show that tracking mode is in progress, the setting is saved.

### Key Option

Option	SEG1	SEG2	SEG3	SEG4	Function of the option
Current restriction rate	0	0	0	0	100% (Factory default)
			0	1	95%
			0	2	90%
			0	3	85%
			0	4	80%
			0	5	75%
			0	6	70%
			0	7	65%
			0	8	60%
			0	9	55%
	1	0	50%		
	1	1			No restriction
Defrost operation	0	1	0	0	Basic
			0	1	Option
Fan speed correction for outdoor unit	0	2	0	0	Basic
			0	1	Option
Quiet mode	0	3	0	0	Low noise (Basic)
			0	1	Level1
			0	2	Level2
			0	3	Level3
Channel address	0	4	A	U	Automatic setting (Factory default)
			0-15		Manual setting for channel 0-15
Snow accumulation prevention control	0	5	0	0	Enabled (Factory default)
			0	1	Disabled

# System configuration

Option	SEG1	SEG2	SEG3	SEG4	Function of the option
Base Heater	0	6	0	0	Disabled
			0	1	Enabled (Factory default)
Operation mode	0	7	0	0	Heat pump (Factory default)
			0	1	Cooling only (Disabled)
			0	2	Heating only
Energy saving mode	0	8	0	0	Disabled (Factory default)
			0	1	Enabled

## ⚠ WARNING

- Incorrect handling of the thermostat, safety valve or other valves may lead to tank rupture or plate heat exchanger damage. When servicing the unit follow the instructions carefully:
  - Always turn off the main power supply when the water supply is being shut off.
  - Test the free operation of the safety valve regularly by opening the valve ensuring the water flows freely.
  - Electrical connection and all servicing of the electrical components should only be carried out by an authorized electrician.
  - Fitting and all servicing of plumbing fixtures should only be carried out by an authorized installer.
  - When replacing the thermostat, safety valve, or any other valve or part supplied with this unit, use only approved parts of the same specification.

## Testing operations

- Check the power supply between the outdoor unit and the auxiliary circuit breaker.
  - 1 phase power supply: L, N
  - 3 phases power supply: R, S, T, N
- Check the control panel.
  - Check that you have connected the power and communication cables correctly. (If the power cable and communication cables are mixed up or connected incorrectly, the PCB will be damaged.)
  - Check the temp. sensor, drain pump/hose, and display are connected correctly.
- Press K1 or K2 on the outdoor unit PCB to run the test mode and stop.

K1 (Number of Press)	KEY operation	7-segment display
1 time	Trial operation in Heating mode	"K" "1" "BLANK" "BLANK"
2 times	Vacuuming (Outdoor unit address 1)	"K" "2" "BLANK" "1"
3 times	Inverter Fault Detection (Comp #1)	"K" "3" "1" "1"
4 times	End Key operation	-

K2 (Number of Press)	KEY operation	7-segment display
1 time	Trial operation in Cooling mode	"K" "4" "BLANK" "BLANK"
2 times	Discharge mode of DC link voltage	"K" "5" "o" "k"
3 times	Forced defrost operation	"K" "6" "BLANK" "BLANK"
4 times	Inverter compressor 1 check	"K" "7" "BLANK" "BLANK"
5 times	End Key operation	-

K3 (Number of Press)	KEY operation	7-segment display
1 time	Initialize (Reset) setting	Same as initial state

- View Mode: When the K4 switch is pressed, you can see information about our system state as below.

K4 (Number of press)	KEY operation	Display on segment	
		SEG1	SEG 2,3,4
1 time	Capacity of outdoor unit	1	16 HP → 0,1,6
2 times	Order frequency of the compressor	2	120 Hz → 1,2,0
3 times	High pressure (kg/cm <sup>2</sup> )	3	15.2 K → 152
4 times	Low pressure (kg/cm <sup>2</sup> )	4	4.3 K → 043
5 times	Discharge temperature Compressor	5	87 °C → 087
6 times	IPM temperature	6	87 °C → 087
7 times	CT sensor value	7	2 A → 020
8 times	Suction temperature	8	-42 °C → -42
9 times	COND OUT temperature	9	-42 °C → -42
10 times	EVA in temperature	A	87 °C → 087
11 times	Compressor top temperature	B	87 °C → 087
12 times	Outdoor temperature	C	-42 °C → -42
13 times	EVI inlet temperature	D	-42 °C → -42
14 times	EVI outlet temperature	E	-42 °C → -42
15 times	Main EEV step	F	2000 → 200
16 times	EVI EEV step	G	300 → 300
17 times	Fan step (ssr or bldc)	H	13 Step → 0, 1, 3
18 times	Current frequency Compressor	I	120 Hz → 1, 2, 0
19 times	EVI SOL EEV step	J	300 → 300
20 times	Inverter pump output	K	100 % → 100

K4 (Number of press) Press and hold the K4 to enter the setting	Displayed content	Display on segment	
		Page 1	Page 2
1 time	Main version	MAIN	Version (ex. 1412)
2 times	Inverter version	INV	Version (ex. 1412)
3 times	EEP version	EEP	Version (ex. 1412)
4 times	Automatically assigned address of the units	AUTO	SEG1,2 Indoor unit: "A", "0" MCU: "C", "1"
			SEG3,4 Address (ex:07)
5 times	Manually assigned address of the units	MANU	SEG1,2 Indoor unit: "A", "0"
			SEG3,4 Address (ex:15)

## FSV Upload / Download

To make an easy installation and service possible, please use an SD card and the wired remote controller's function.

Field Setting Value		
10**	Remote Controller	>
20**	Water Law	>
30**	DHW	>
40**	Heating	>
50**	Others	>
Simple Setting		
FSV Upload / Download		

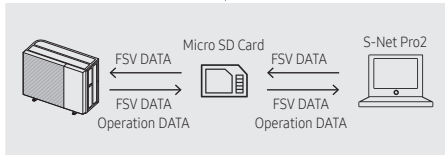

### How to upload or download the Field Setting Values (example)

- 1 Insert an SD card into the Sub PBA SD Card slot on the pump integrated outdoor unit.
- 2 Select Field Setting Value in the Service mode.
- 3 Press the  $\wedge$  or  $\vee$  button to select FSV Upload / Download.

### NOTE

- Upload: Uploads the FSV data of the pump integrated outdoor unit to the SD card.
  - Download: Downloads the FSV data of the SD card to the pump integrated outdoor unit.
- 1 Download the wired remote controller image, change the file name to "IMAGE.BIN," and then download to microSD Card.
  - 2 Download the wired remote controller program, change the file name to "MICOM.BIN," and then download to microSD Card.
  - 3 Insert the microSD card with the wired remote controller active, and then reset the system. For system reset, press the  $\leftarrow$  and  $\otimes$  buttons at the same time for more than 5 seconds.
  - 4 The download to microSD card is performed as follows:
    - Download proceeds in the order of first IMAGE and then MICOM.
    - When the update fails, the wired remote controller is reset automatically and the update proceeds again.
  - 5 When the download is finished, tracking starts automatically. When tracking is completed, remove the microSD Card.
- Add the function of FSV download / upload and data backup with SD card.
  - When FSV is download / upload, using the remote controller.

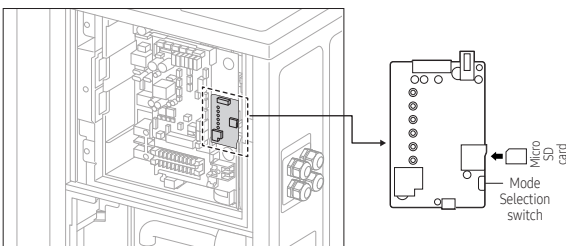

Left position: Field Setting Value (FSV) mode

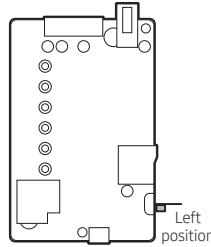

Right position: Operating Data Backup mode

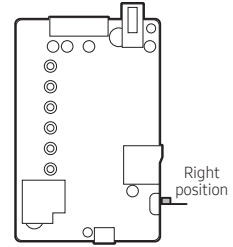

- Micro SD card is a separate purchase, using 8 ~ 32GB is possible.

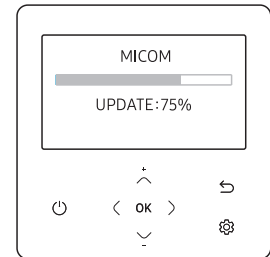
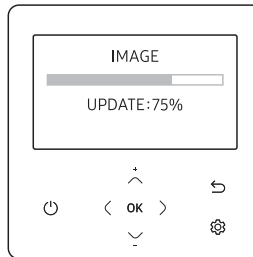

### CAUTION

- Be sure to use the microSD Card after formatting in FAT16 or FAT32.
- The microSD Card supports the SD or SDHC with the capacity of 1 GB to 32 GB.
- The update is performed only when the file version in the microSD Card differs from the one of the Wired Remote Controller.
- When the screen is frozen for more than 3 minutes after completing the microSD card update by 100%, product inspection is required.
- Delete the files except for the ones for download. (Only IMAGE.BIN and MICOM.BIN are required.)

# Charging refrigerant

- Measure the quantity of the refrigerant according to the length of the liquid side pipe. Due to the small quantity of the R-290 charge, an accurate weighing of the R-290 charged in the system is mandatory to ensure proper performance.

## NOTE

- a Factory refrigerant charge of the product: see unit name plate.
- b Additional refrigerant amount charged in the field. (Refer to the above information for the quantity of refrigerant replenishment.)

## Important information: regulation regarding the refrigerant used

Please fill in the following with indelible ink on the refrigerant charge label supplied with this product and on this manual.

- ① the factory refrigerant charge of the product.
- ② the additional refrigerant amount charged in the field.

## CAUTION

- The filled-out label must be adhered in the proximity of the product charging port. (ex. onto the inside of the stop valve cover.)

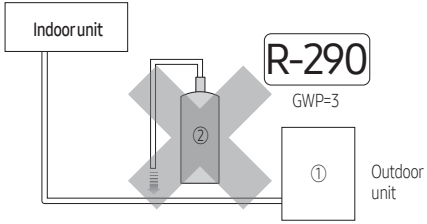

Unit	kg	tCO <sub>2</sub> e
①, a		
②, b	DO NOT CHARGE	

Refrigerant type	GWP value
R-290	3

- GWP: Global Warming Potential
- Calculating tCO<sub>2</sub>e: kg x GWP/1000



# Troubleshooting

## Troubleshooting of error code

Display	Explanation	Error Source
E108	Setting Address Duplicate Error	OUTDOOR UNIT/ Hydro Unit
E120	Zone2 Indoor Room Temperature Sensor Short/Open	Hydro Unit
E121	Error of ROOM Temperature Sensor in Indoor unit short/open	Hydro Unit
E122	Error of Evaporator_in Sensor of Indoor unit short/open	Hydro Unit
E123	Error of Evaporator_out Sensor of Indoor unit short/open	Hydro Unit
E162	Outdoor UNIT EEPROM Error	OUTDOOR UNIT
E163	EEPROM OPTION SETTING Error	OUTDOOR UNIT
E177	In hydro box, take place emergency signal Error	Hydro Unit
E201	CONTROL KIT / Outdoor UNIT Communication Error (Matching Error)	OUTDOOR UNIT
E202	CONTROL KIT / Outdoor UNIT Communication Error	OUTDOOR UNIT
E205	Communication Error Between Outdoor Unit Inv Micom - Fan Motor Micom	OUTDOOR UNIT
E221	Outdoor Temperature Sensor Error (open/short)	OUTDOOR UNIT
E231	COND_OUT Main Temperature Sensor Error (open/short)	OUTDOOR UNIT
E241	COND OUT Sensor of Outdoor Unit breakaway Error	OUTDOOR UNIT
E251	Discharge Temperature Sensor Error (open/short)	OUTDOOR UNIT
E262	Discharge Sensor breakaway Error	OUTDOOR UNIT
E266	Comp Top Sensor breakaway Error	OUTDOOR UNIT
E269	SUCTION Sensor breakaway Error	OUTDOOR UNIT
E276	Compressor Top Temperature Sensor Error (open/short)	OUTDOOR UNIT
E291	High Pressure Sensor Error (open/short)	OUTDOOR UNIT
E296	Low Pressure Sensor Error (open/short)	OUTDOOR UNIT
E308	Suction Sensor Error (open/short)	OUTDOOR UNIT
E321	EVI Inlet Sensor Error (open/short)	OUTDOOR UNIT
E322	EVI Outlet Sensor Error (open/short)	OUTDOOR UNIT
E381	Outdoor Inverter1 Controller PCB Overheat	OUTDOOR UNIT
E403	Protect for Freezing Control Error	OUTDOOR UNIT
E407	COMP down due to High PressureSensor Protection Control	OUTDOOR UNIT
E410	COMP down due to Low PressureSensor Protection Control	OUTDOOR UNIT
E416	Comp down due to discharge Temperature	OUTDOOR UNIT
E425	Outdoor Reverse Phase or Missing Phase Detect Error	OUTDOOR UNIT
E428	COMP down by Compression Ratio control Error	OUTDOOR UNIT
E436	Protect for Freezing Burst Control Error	OUTDOOR UNIT
E438	EVI EEV Opening Error	OUTDOOR UNIT

Display	Explanation	Error Source
E439	Refrigerant Leakage Error (Detect when the system is not operated)	OUTDOOR UNIT
E440	Forbid Heat mode Operation when Outdoor Temperature is over 43 °C	OUTDOOR UNIT
E441	Forbid Cooling Mode when Outdoor Temperature is Low 10 °C	OUTDOOR UNIT
E443	No startup due to Low pressure	OUTDOOR UNIT
E458	Outdoor unit Fan Error	OUTDOOR UNIT
E461	[Inverter] COMP Operating failure	OUTDOOR UNIT
E462	All currency control COMP Stop Or CT2 Low currency	OUTDOOR UNIT
E464	[Inverter] DC peak Error	OUTDOOR UNIT
E465	Compressor V limit Error	OUTDOOR UNIT
E466	[Inverter] DC-Link voltage under/over Error	OUTDOOR UNIT
E467	COMP Revolute Error	OUTDOOR UNIT
E468	[Inverter] Comp Current Sensor Error	OUTDOOR UNIT
E469	DC Link Sensor Error	OUTDOOR UNIT
E471	[Inverter] OTP Error → Outdoor unit EEPROM Read/Write Error (OTP error)	OUTDOOR UNIT
E474	[Inverter] IPM Heat Sink Error	OUTDOOR UNIT
E475	Outdoor unit BLDC Fan Error	OUTDOOR UNIT
E483	H/W DC_link over voltage Error	OUTDOOR UNIT
E484	PFC Overload Error	OUTDOOR UNIT
E485	[Inverter] Input Current Sensor Error (open/short)	OUTDOOR UNIT
E488	AC Input Voltage Sensor Error	OUTDOOR UNIT
E500	IPM Overheat Error for Inverter COMP	OUTDOOR UNIT
E507	Comp Down due to high pressure or High Pressure Switch Open	OUTDOOR UNIT
E536	PHE refrigerant leakage error	OUTDOOR UNIT
E554	Refrigerant leakage error (detection during system operation)	OUTDOOR UNIT
E563	INDOOR UNIT Mixed Install Error	OUTDOOR UNIT
E590	[Inverter] Data flash Error	OUTDOOR UNIT
E897	Water Tank in sensor error(Short/Open)	Indoor unit
E899	Zone1 Tw Temperature Sensor Short/Open	Hydro Unit
E900	Zone2 Tw Temperature Sensor Short/Open	Hydro Unit
E901	Water Inlet Sensor Error (open/short)	OUTDOOR UNIT
E902	Water Outlet Sensor Error (open/short)	OUTDOOR UNIT
E904	Water TANK Sensor SHORT / OPEN	Hydro Unit
E906	Outdoor EVA in Sensor Error (open/short)	OUTDOOR UNIT
E907	Error due to pipe rupture protection	CONTROL KIT
E908	Error due to freeze prevention(Re-Operation is possible)	CONTROL KIT
E909	Error due to freeze prevention(Re-Operation is impossible)	CONTROL KIT
E910	Water Temperature Sensor on water Outlet pipe is detached	Hydro Unit
E911	Flow Swtich Open Error	Hydro Unit

# Troubleshooting

---

Display	Explanation	Error Source
E912	Flow Switch Close Error	Hydro Unit
E913	Six times detection for Flow Switch Error (Re-Operation is not possible)	CONTROL KIT
E914	Error due to Incorrect Thermostat Connection	Hydro Unit
E915	Error on DC fan (Non-operating)	CONTROL KIT
E916	Mixing Sensor Short/Open	Hydro Unit
E919	Disinfection Operation Incomplete Error	Hydro Unit
E973	Water pressure sensor research (Short/Open)	OUTDOOR UNIT

# Technical data

## Refrigerant circuit diagram

- AE050CX1B\*\*/AE080CX1B\*\*

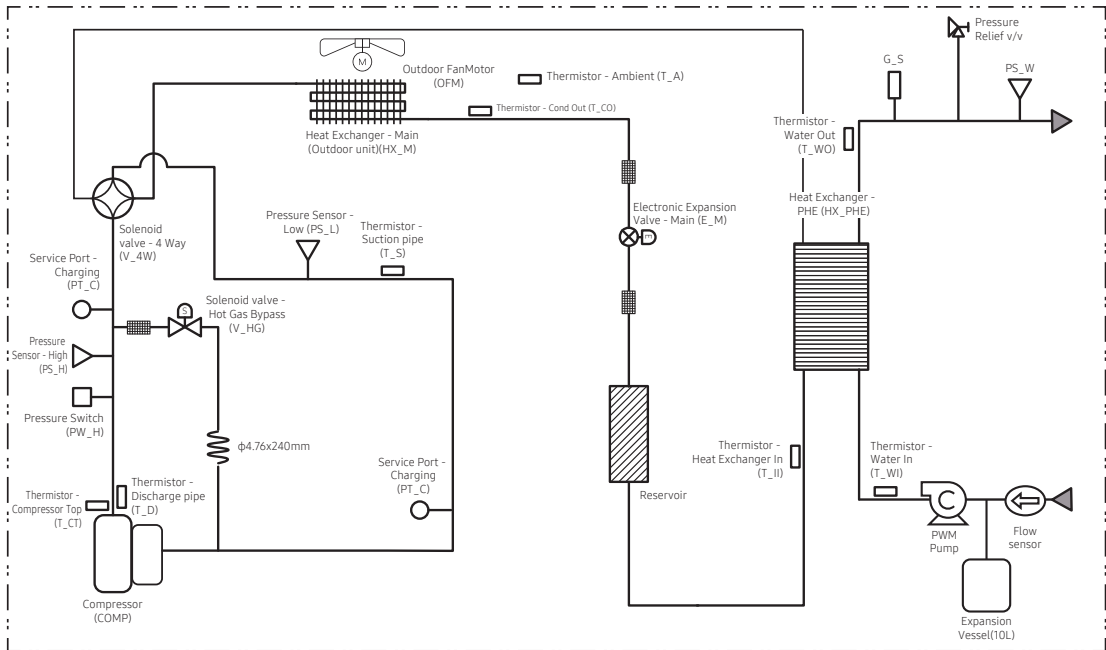

Part	Description
COMP	Compressor
HX_M	Heat Exchanger - Main (Outdoor unit)
HX_PHE	Heat Exchanger - PHE
OFM	Outdoor Fan Motor
AC	Accumulator
PS_H	Pressure Sensor - High
PS_L	Pressure Sensor - Low
PS_W	Pressure Sensor - Water
PW_H	Pressure Switch - High
G_S	Gas Separator
E_M	Electronic Expansion Valve - Main

Part	Description
PT_C	Service Port - Charging
V_4W	Solenoid valve - 4 Way
V_HG	Solenoid valve - Hot Gas Bypass
T_A	Thermistor - Ambient
T_CO	Thermistor - Cond Out
T_CT	Thermistor - Compressor Top
T_D	Thermistor - Discharge pipe
T_II	Thermistor - Heat Exchanger In
T_S	Thermistor - Suction pipe
T_WI	Thermistor - Water In
T_WO	Thermistor - Water Out

# Technical data

- AE120CXYB\*\*/AE160CXYB\*\*

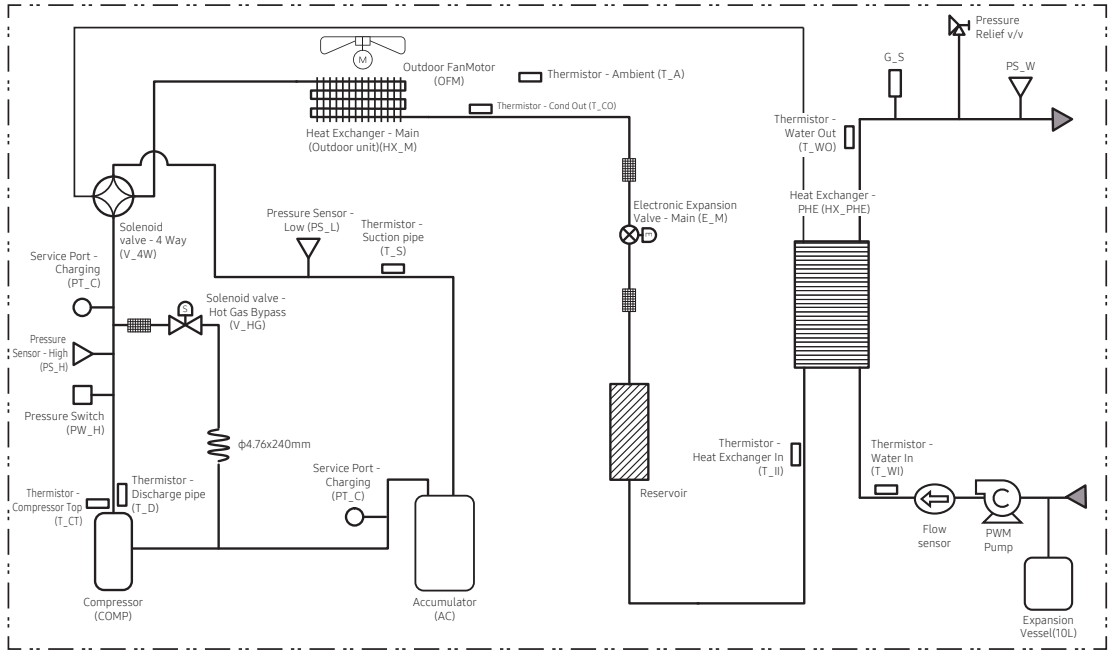

Part	Description
COMP	Compressor
HX_M	Heat Exchanger - Main (Outdoor unit)
HX_PHE	Heat Exchanger - PHE
OFM	Outdoor Fan Motor
AC	Accumulator
PS_H	Pressure Sensor - High
PS_L	Pressure Sensor - Low
PS_W	Pressure Sensor - Water
PW_H	Pressure Switch - High
G_S	Gas Separator
E_M	Electronic Expansion Valve - Main

Part	Description
PT_C	Service Port - Charging
V_4W	Solenoid valve - 4 Way
V_HG	Solenoid valve - Hot Gas Bypass
T_A	Thermistor - Ambient
T_CO	Thermistor - Cond Out
T_CT	Thermistor - Compressor Top
T_D	Thermistor - Discharge pipe
T_II	Thermistor - Heat Exchanger In
T_S	Thermistor - Suction pipe
T_WI	Thermistor - Water In
T_WO	Thermistor - Water Out



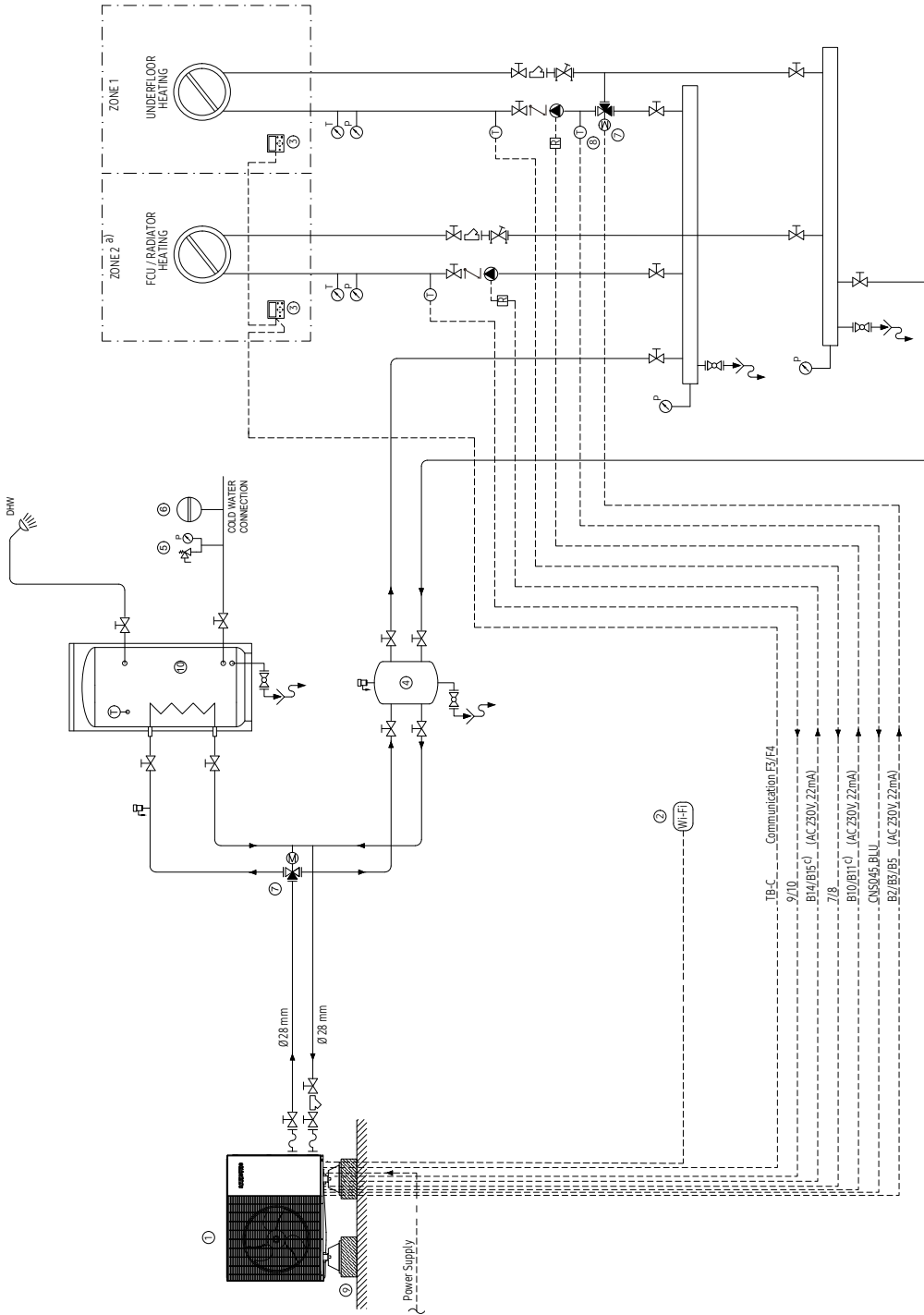









# Piping & Wiring diagram



- When both zones are simultaneously Thermo On, the operation is performed based on Zone 2. Set the zone with the higher set temperature to Zone 2.
- Air vent included in pump integrated outdoor unit. In case that the water piping would be located in a higher position than the air vent of the pump integrated outdoor unit, it is necessary to add additional one at the highest position of the water circuit.
- Pumps for radiator and floor heating can be regulated (on/off) by tank integrated hydro unit (terminals B10/B11 and B14/B15) or their own regulators. Based on the current logic only with two zones control with wired remote controller. Not with thermostat.

# Technical data

No.	Legend
①	Samsung EHS pump integrated outdoor unit
②	Samsung EHS Wi-Fi Kit
③	Samsung Wired Remote Controller (MWR-WW10N)
④	Balancing vessel (Decoupler)
⑤	Safety group (Safety valve, Manometer)
⑥	Expansion vessel
⑦	3way mixing valve for floor heating (in case of combination with radiators)
⑧	Mixing valve temperature sensor <sup>b)</sup>
⑨	Vibro-isolating mounting bases
⑩	Domestic hot water tank (3rd party)

Symbols	
	Circulation pump
	Shut off valve
	Ball valve
	Check valve
	Strainer
	Temperature gauge
	Pressure gauge
	Safety valve
	3way mixing valve
	Regulation valve
	Temperature sensor
	Air vent (apply when necessary) <sup>d)</sup>
	Relay







A3

This appliance is filled with R-290.